

WLA-230-AB/EN5424

EN 54-24 On-Wall / Ceiling-Speaker
in ABS with 2x 6 Watt Power for AB - Systems

EN
54-24



optionally available:
**Multiple entry including
strain relief**

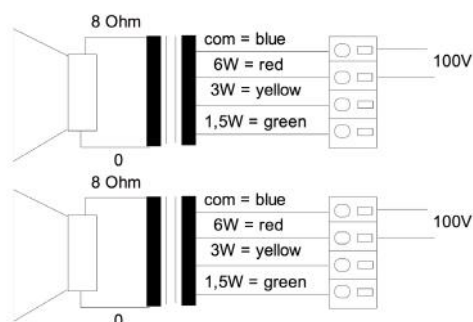
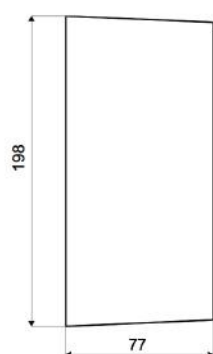
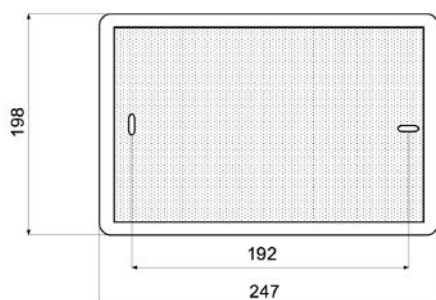

| TECHNICAL DATA | WLA-230-AB/EN5424 |
|------------------------------|------------------------------|
| Loudspeaker: | 2x 120x70mm broadband |
| Power-Consumption: | 2x 100V-6-3-1,5W |
| Frequency-Range: | 80-20 000 Hz |
| EN-Sensitivity 1W/4M: | 74,5 dB (1x), 80,5 dB (2x) |
| SPL max 6W/4M: | 82,14 dB (1x), 88,14 dB (2x) |
| SPL 1W/1M max. EASE/Ulysses: | 96 dB (2,5 kHz) (double) |
| SPL 6W/1M max. EASE/Ulysses: | 103 dB (2,5 kHz) (double) |
| Radiation H (0,5/1/2/4KHz): | 130°/98°/95°/65° (single) |
| Radiation V (0,5/1/2/4KHz): | 130°/119°/105°/70° (single) |
| Dimension: | 247 x 198 x 77mm |
| Weight: | 1,4 kg |
| Material: | ABS / Metal-Grill |
| Color: | black |
| Certificate-Nr.: | 1293-CPD-0230 |
| Order-Nr.: | WLA-230-AB/EN5424-BK |

- Two autonomous loudspeaker/100V-transformer per system
- Easy mounting through Quick-Snap-Rear-Panel & Safety Screws
- Enables operation of speaker via two discrete cable-lines
- In case of failure of one line, continuous function of the second line
- Custom colors & wet-room-version with ALU-grill obtainable
- Three touch-secure 100V-tappings
- Ceramic clamp & thermal fuse by request
- Optional multiple entry including strain relief available

WLA-230-AB/EN5424

EN 54-24 On-Wall / Ceiling-Speaker
in ABS with 2x 6 Watt Power for AB - Systems

Radiation

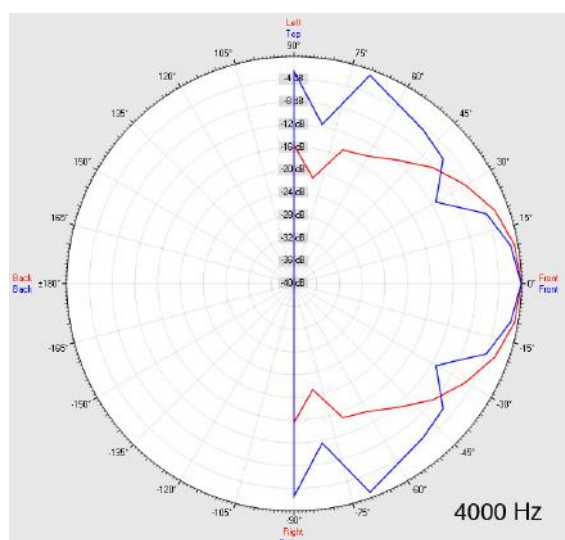
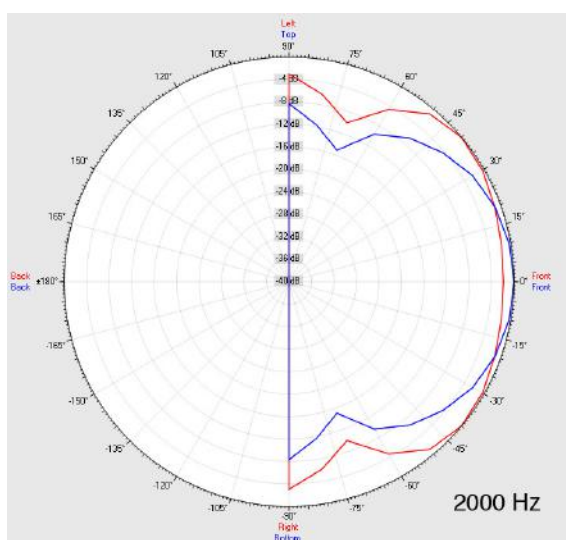
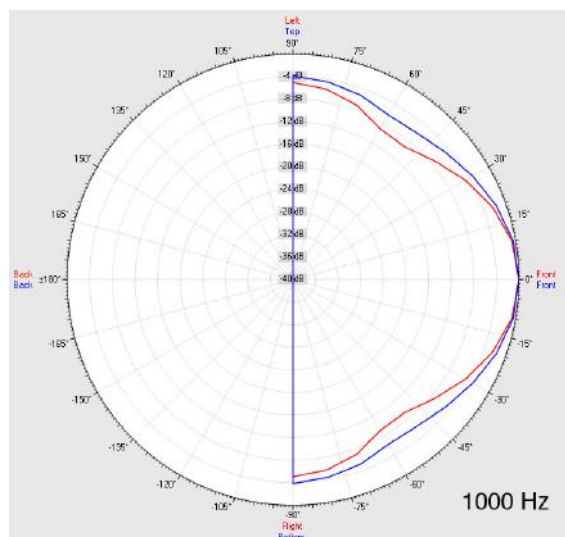
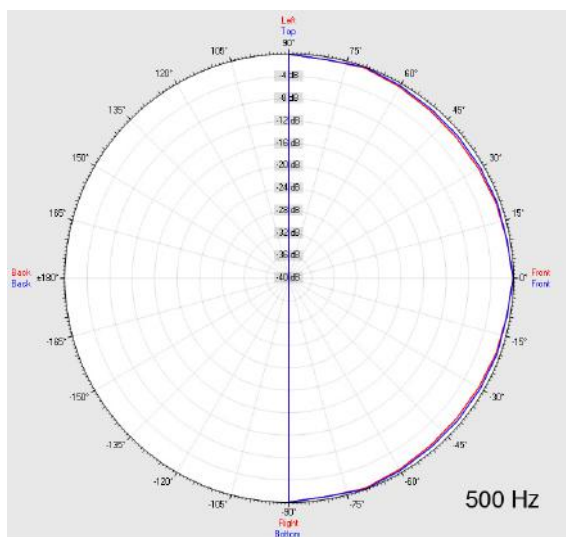

| Test method | Axis | 500 Hz | 1000 Hz | 2000 Hz | 4000 Hz |
|--------------|------|--------|---------|---------|---------|
| EN 54-24 | HOR | 130° | 98° | 95° | 65° |
| EN 54-24 | VER | 130° | 119° | 105° | 70° |
| EASE/Ulysses | HOR | 180° | 70° | 125° | 70° |
| EASE/Ulysses | VER | 180° | 180° | 90° | 40° |

WLA-230-AB/EN5424

EN 54-24 On-Wall / Ceiling-Speaker
in ABS with 2x 6 Watt Power for AB - Systems



Elektroakustische Komponenten

Isobar-Diagramm

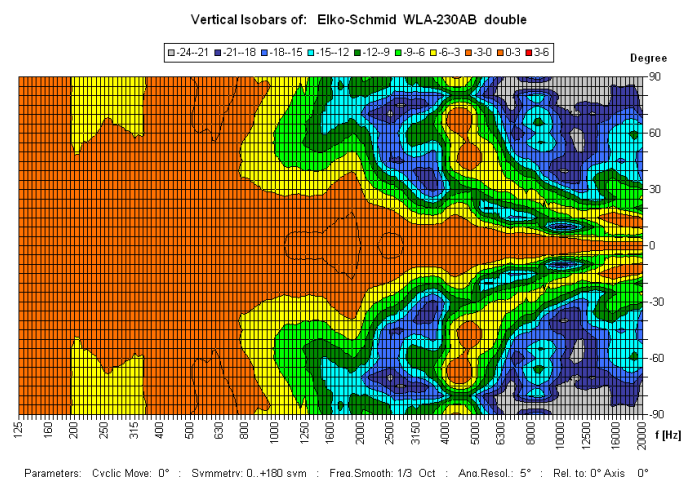
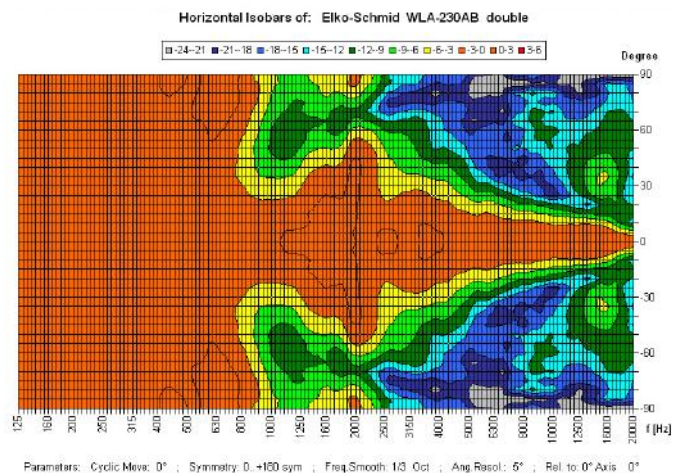

CE

1293

Elko Schmid GmbH & Co. KG
Glauchauer Str. 30, D-08058 Zwickau

11

DoP: 498058129314-OWS-PN-0014

EN 54-24

Loudspeaker for voice alarm systems for
fire detection and fire alarm systems for buildings

WLA-230-AB/EN5424

Intended Option:
Type A