

SLB-240-AB-10W/EN5424

EN 54-24 Ceiling-Speaker
in Metal with 2x 10 Watt Power for AB - Systems

EN
54-24

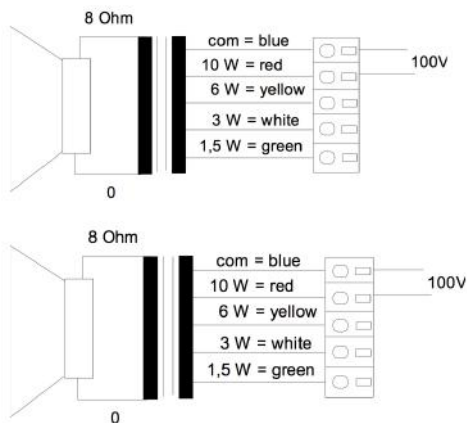
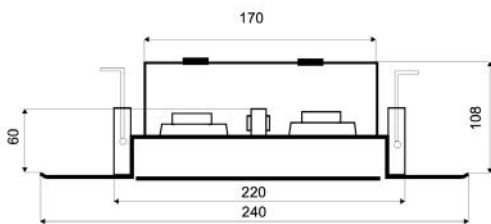

TECHNICAL DATA

SLB-240-AB-10W/EN5424

Loudspeaker:	2x 120 x 70 mm broadband
Power-Consumption:	2x 100V-10-6-3-1,5W
Frequency-Range:	120-20 000 Hz
EN-Sensitivity 1W/4M:	72 dB (1x), 78 dB (2x)
SPL max 10W/4M:	83 dB (1x), 89 dB (2x)
SPL 1W/1M max. EASE/Ulysses:	99 dB (1,8 kHz) (double)
SPL 10W/1M max. EASE/Ulysses:	106 dB (1,8 kHz) (double)
Radiation H (0,5/1/2/4KHz):	180°/180°/170°/89° (single)
Radiation V (0,5/1/2/4KHz):	180°/180°/170°/89° (single)
Dimension:	240 x 108 mm with firedome
Ceiling Cut-out:	220 mm
Suitable slab thickness:	1 mm - 30 mm
Weight:	1,9 kg with firedome
Material:	Metal
Color:	white similar to RAL 9010
Certificate-Nr.:	1293-CPR-0425
Order-Nr.:	SLB-240-AB-10W/EN5424

- Only 240 mm external diameter on two oval 120 mm systems
- 108 mm mounting depth with firedome
- Two autonomous loudspeaker/100V-transformer per system
- Enable operation of speaker via two discrete cable-lines
- Two-part design via bayonet mounting
- Ball-attack protection according DIN 18032-3 included
- Custom colors by request
- Four touch-secure 100V-tappings
- Ceramic clamp & thermal fuse by request

SLB-240-AB-10W/EN5424

EN 54-24 Ceiling-Speaker
in Metal with 2x 10 Watt Power for AB - Systems

Radiation

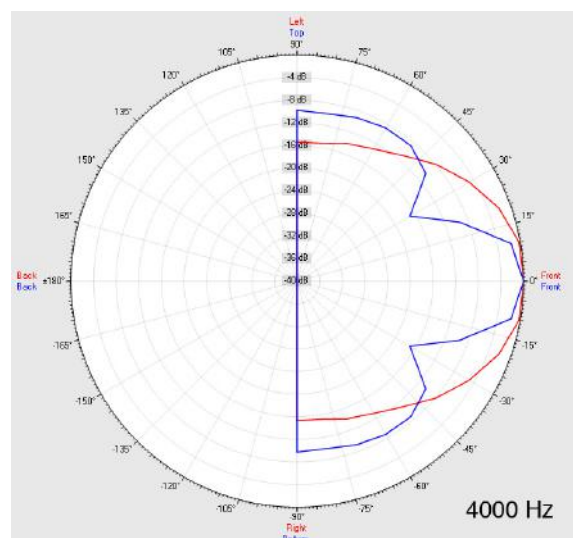
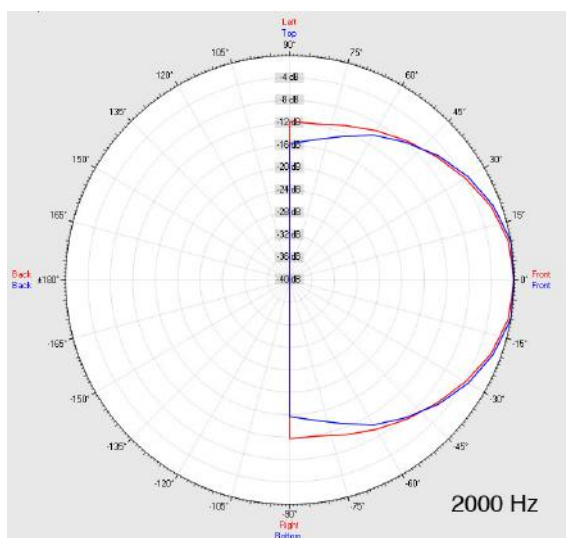
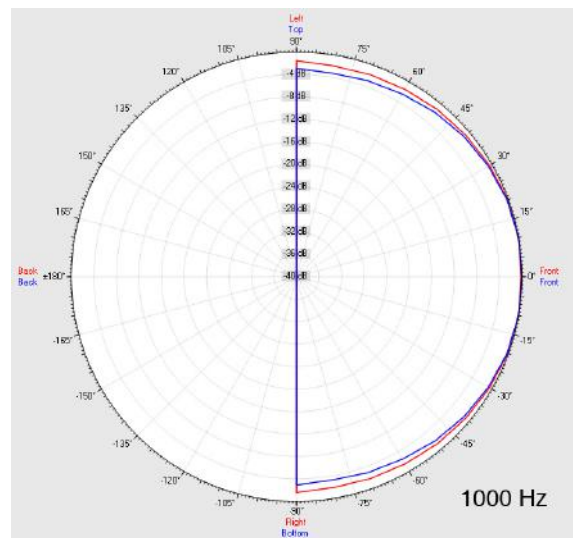
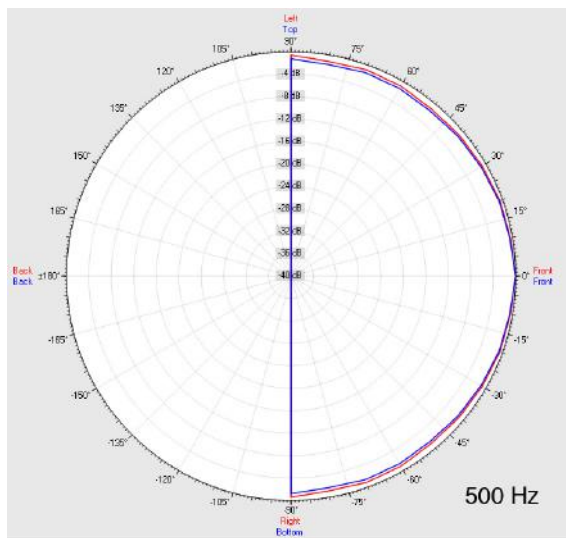

Test method	Axis	500 Hz	1000 Hz	2000 Hz	4000 Hz
EN 54-24	HOR	180°	180°	170°	89°
EN 54-24	VER	180°	180°	170°	89°
EASE/Ulysses	HOR	180°	180°	80°	70°
EASE/Ulysses	VER	180°	180°	85°	35°

SLB-240-AB-10W/EN5424

EN 54-24 Ceiling-Speaker
in Metal with 2x 10 Watt Power for AB - Systems



Elektroakustische Komponenten

Isobar-Diagramm

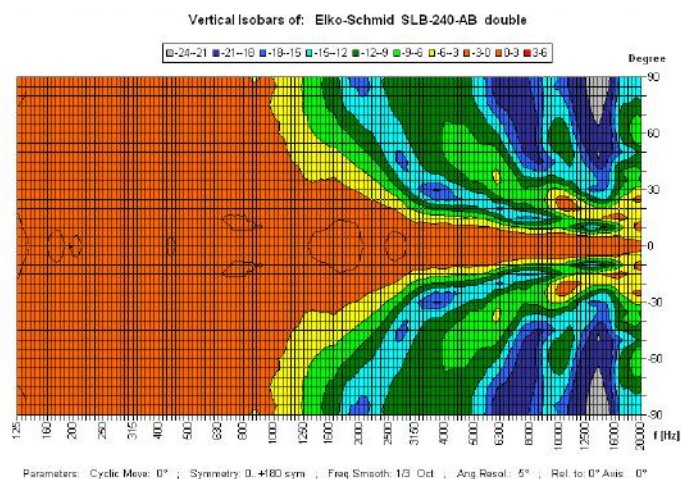
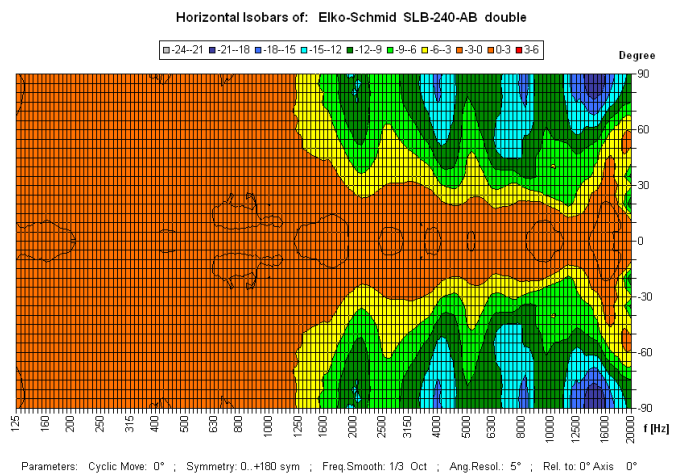

CE

1293

Elko Schmid GmbH & Co. KG
Glauchauer Str. 30, D-08058 Zwickau

14

DoP: 498058129314-ICS-PN-0010

EN 54-24

Loudspeaker for voice alarm systems for
fire detection and fire alarm systems for buildings

SLB-240-AB-10W/EN5424

Intended Option:
Type A